

## Spatial Light Modulator – 1920 x 1200

**E-Series:** Educational, Economical & Entry-level

Meadowlark Optics is pleased to introduce our latest E-Series Spatial Light Modulator (SLM). Don't let the name fool you; with improved specifications over our previous model, it is anything but entry-level. It is, however, economical and ideally suited for educational labs with a limited budget. Liquid Crystal on Silicon (LCoS) Spatial Light Modulators (SLMs) are uniquely designed for pure phase applications and incorporate analog data addressing with high refresh rates. This combination provides users with the fastest response times and highest phase stabilities commercially available. Meadowlark offers both transmissive and reflective SLMs in either one- or two-dimensions. Phase-only SLMs can also be used for amplitude-only or a combination of both.

**High Phase Stability** - Meadowlark Optics is known for having the fastest SLMs with the least amount of phase ripple on the market. Our backplanes are custom designed with high refresh rates and direct analog drive schemes, resulting in phase ripple for most configurations between 0.10 – 0.30%, with some configurations around 1 – 2%. For customers who require even better performance, customization is possible with phase ripple as low as 0.025% (0.0008  $\pi$  radians). Phase ripple is quantified by measuring the variation in intensity of the 1<sup>st</sup> order diffracted spot as compared to the mean intensity while writing a blazed phase grating to the SLM.

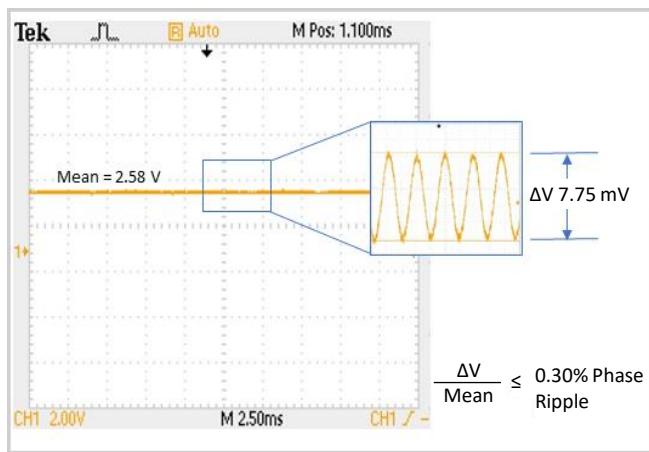

1<sup>st</sup> order Intensity when writing a phase ramp to the SLM

### Hardware Interface Options -

The 1920 x 1200 SLM is offered with a 60 Hz HDMI Controller enabling customers to take advantage of our fast liquid crystal response times. Standard hardware includes output trigger for synchronization.

### SLM Features

- • •
- High resolution
- High Phase Stability
- Pure analog phase control
- High first order efficiency
- High reflectivity
- High power handling
- Compact design
- Wavelengths from 400-1650 nm

### Software Features

- • •
- Output Trigger
- Image Generation
- Automated Sequencing
- Wavefront Calibration
- Global and Regional Look Up Tables



**Diffraction Efficiency (1st-order)** - This is the percentage of light measured in the 1st-order when writing a linear repeating phase ramp to the SLM as compared to the light in the 0<sup>th</sup> order when no pattern is written to the SLM. Diffraction efficiency varies as a function of the number of phase levels in the phase ramp. The plot to the right shows sample 1<sup>st</sup> order diffraction efficiency measurements, as a function of the phase ramp period, taken at various wavelengths.

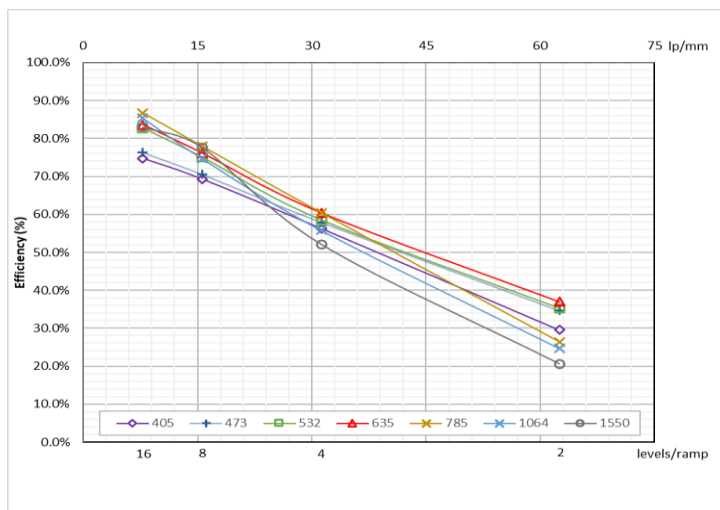

### Diffraction Efficiency (0th-order)

This is the amount of light measured in the 0<sup>th</sup>-order (dc) when the SLM is written with various solid gray levels as a percentage of the amount of light measured when the SLM is replaced with a reference mirror. Therefore, it takes into account losses in transmission through the coatings on the SLM cover window, as well as diffraction losses due to the pixel pads being less than 100% fill-factor. In addition to these losses, this measurement also accounts for losses due to imperfect reflectivity of the aluminum pixel mirrors, or in the case of a dielectric mirror coated model the measurement accounts for losses due to imperfect reflectivity of this dielectric mirror coating. The 0<sup>th</sup>-order diffraction efficiency will vary as a function of wavelength due to differences in coating materials and designs. It will also vary with pixel value due to the inherent change in the index of refraction of the liquid crystal that results in a change in the Fresnel reflections inside the liquid crystal cell. Most standard SLMs will range from 70 – 90%, while the dielectric mirror coated models will range from 92 – 98%.

### High Efficiency Dielectric Mirror Coating

All the light reflecting off the SLM is modulated – including the light between the aluminum pixel electrodes. The reflective pixel structure associated with a LCoS SLM backplane acts as an amplitude grating diffracts some light into higher orders. Optically, the active area of the backplane is converted into a flat dielectric mirror by depositing dielectric layers to eliminate the amplitude and optical path variations associated with the underlying aluminum pixel structure. The dielectric stack is kept thin to minimize any drop in electric field across the LC layer as shown in the figure below. In other words, there are no abrupt changes in phase modulation (such as dead zones) between pixels due to the smoothing which results from separating the LC modulator from the driving electrodes.

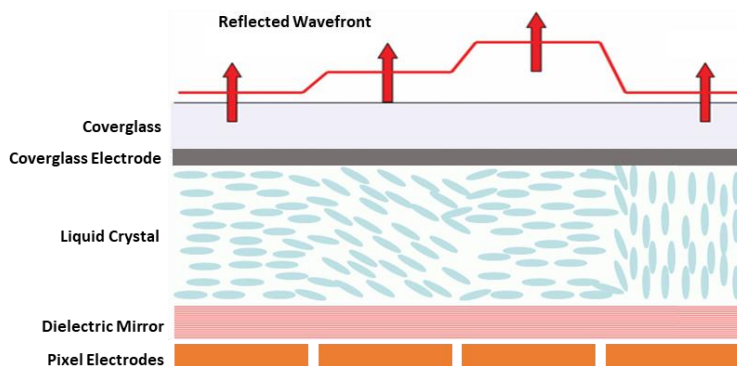



## 1920 x 1200 Analog Spatial Light Modulator

**Resolution:** 1920 x 1200  
**Array Size:** 15.36 x 9.60 mm  
**Pixel Pitch:** 8.0 x 8.0  $\mu\text{m}$   
**Backplane Refresh:** 1.35 kHz

**Fill Factor:** 95.6%  
**0<sup>th</sup> Order Diffraction Efficiency:** 76 - 91%  
**0<sup>th</sup> Order Diffraction Efficiency:** 92 – 98% (dielectric mirror)  
**Controller:** HDMI

Standard Calibration Wavelengths	STANDARD SPEED Liquid Crystal Response Time			Calibrated Wavefront Distortion
	AR Coating Range 350 – 850 nm	AR Coating Range 500 – 1200 nm	AR Coating Range 850 – 1650 nm	
405 nm	$\leq 13.4$ ms			$\lambda/5$
532 nm	$\leq 14.0$ ms	$\leq 17.0$ ms	–	$\lambda/7$
635 nm	$\leq 14.5$ ms	$\leq 17.5$ ms	–	$\lambda/8$
785 nm	$\leq 20.5$ ms	$\leq 22.5$ ms	–	$\lambda/10$
1064 nm	–	$\leq 25.0$ ms	$\leq 27.5$ ms	$\lambda/10$
1550 nm	–	$\leq 43.0$ ms	$\leq 45.0$ ms	$\lambda/12$

### EDM-19x12-488-850-HDM8-WCS1

*Model Number Guide:*



**Software** - Meadowlark Optics' SLMs are supplied with a Graphical User Interface and software development kits that support LabVIEW, Matlab, Python and C++. The software allows the user to generate images, to correct aberrations, to calibrate the global and/or regional optical response over 'n' waves of modulation, to sequence at a user defined frame rate, and to monitor the SLM temperature.

**Global or Regional Calibrations** - Regional calibrations provide the highest spatial phase fidelity commercially available by regionally characterizing the phase response to voltage and calibrating on a pixel-by-pixel basis.

#### Image Generation Capabilities

*Bessel Beams:* Spiral Phase, Fork, Concentric Rings, Axicons

*Lens Functions:* Cylindrical, Spherical

*Gratings:* Blazed, Sinusoid

*Diffraction Patterns:* Stripes, Checkerboard, Solid, Random Phase, Holograms, Zernike Polynomials, Superimpose Images

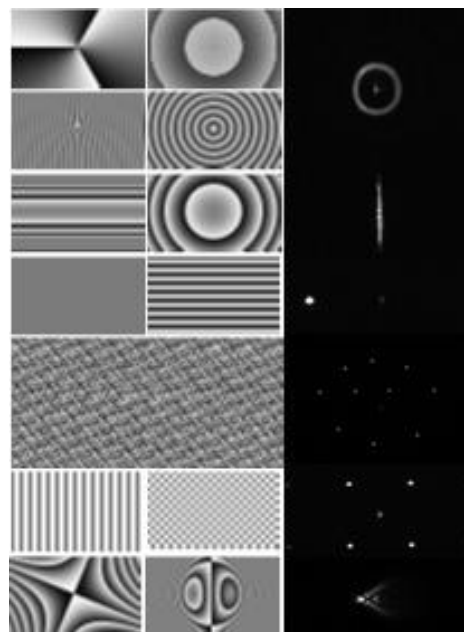



## Spatial Light Modulator System Add-ons -

**Liquid Cooling System** - A copper block is attached to the back of the optical head to draw heat out of the SLM chip. The copper block is coupled via 2 meters of quick-disconnect tubing to cooling unit containing an external pump, radiator, and fan to cool the liquid down to ambient temperature. Includes one bottle of liquid coolant.

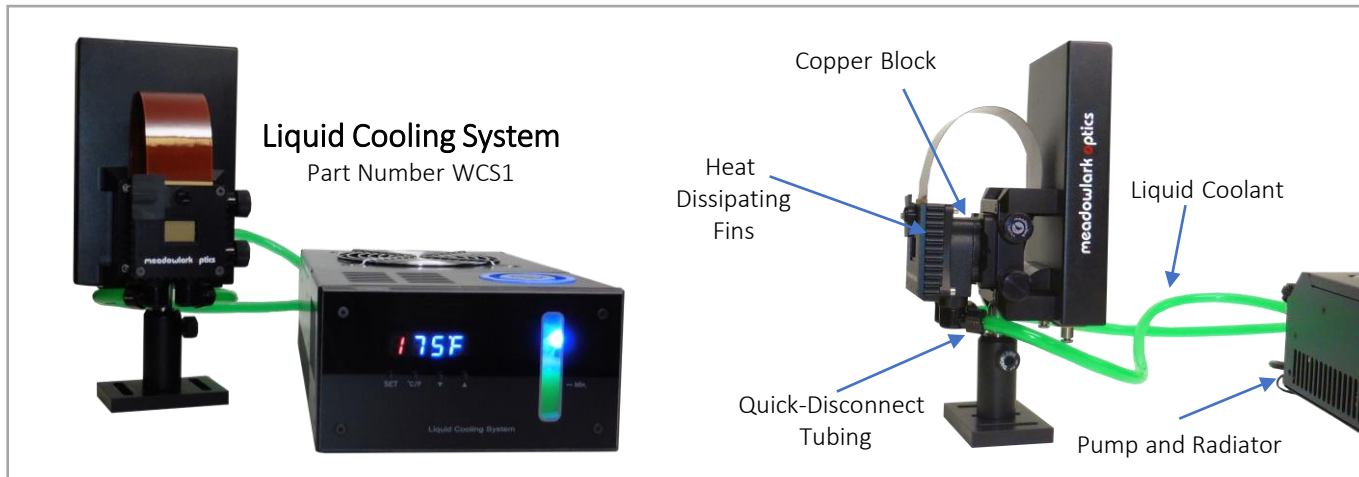

### E19x12

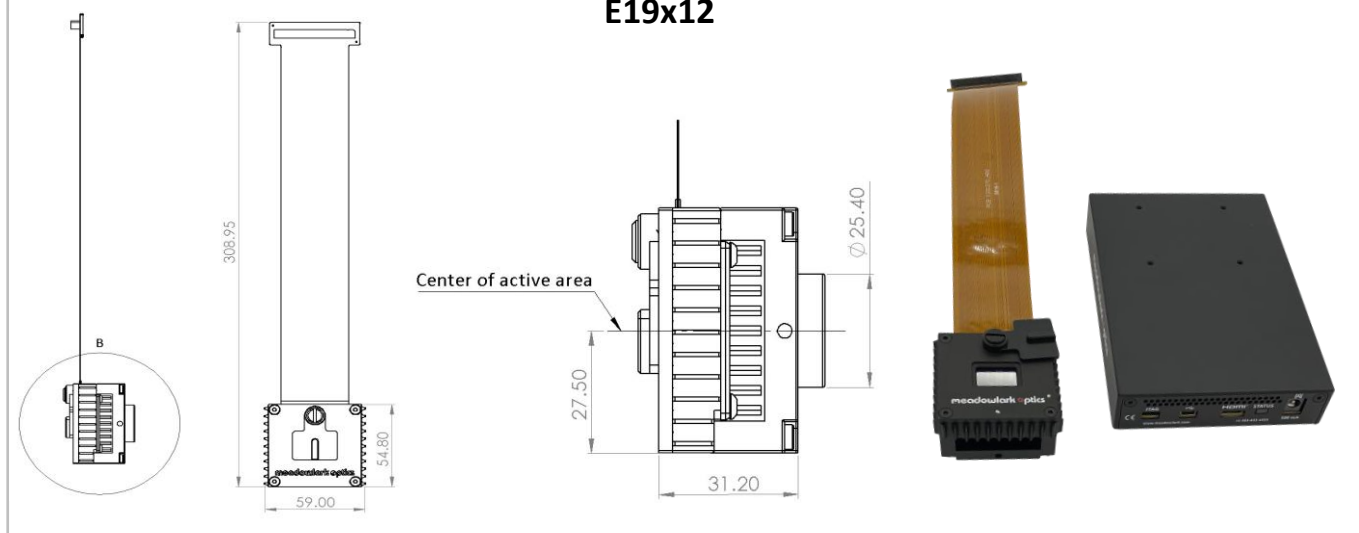

### E19x12 with optional tip/tilt stage

