

LASER 2000

For UK & Ireland enquiries:

+44 (0) 1933 461 666

sales@laser2000.co.uk

photonics.laser2000.co.uk



PICOQUANT

MicroTime 200 STED

Super-resolution add-on for the confocal time-resolved microscopy platform



confocal
STED

Vision

The MicroTime 200 ...

The MicroTime 200 is a high-end confocal fluorescence lifetime microscope platform with single molecule sensitivity. It integrates compact picosecond pulsed diode lasers along with piezo or galvo scanners, single photon sensitive detectors, and outstanding timing electronics with picosecond resolution. The unique combination of cutting-edge technology allowed to design an open microscopy platform that can not only be used to acquire high-quality Fluorescence Lifetime Images (FLIM), but also to perform single molecule Förster Resonance Energy Transfer (FRET) studies as well as correlation measurements such as Fluorescence (Lifetime) Correlation Spectroscopy (FCS/FLCS). The open design philosophy of the MicroTime 200 even permits to combine the instruments with, e.g., Atomic Force Microscopes (AFM) or spectrographs. Data acquisition and analysis is performed with the established SymPhoTime 64 software that integrates a multitude of intuitive analysis procedures.

“This is simple super-resolution microscopy: We attached a STED-dye with click-chemistry and got impressive high resolution images of the E. coli chromosome.”

Mike Heilemann, Goethe University Frankfurt, Germany

... and STED

STimulated Emission Depletion microscopy (STED) allows imaging with a resolution far below the diffraction limit of light, and thus enables researchers to investigate their samples in greater detail than possible with classical confocal microscopy. The principle was originally conceived by Stefan Hell (Max-Planck Institute Göttingen, Germany) and has now come to a point where its usability has evolved beyond its application in highly specialized laboratories. The integration of STED into the confocal fluorescence microscope MicroTime 200 has been driven towards highest robustness and ease-of-

use. The researcher can perform STED microscopy without lengthy alignment preparations while still having the choice to modify the system and use the full capability of the open microscopy platform MicroTime 200.



In STED microscopy, fluorophores are excited in a tightly focussed spot (green). Just after excitation, a donut-shaped laser focus of a longer wavelength (red) de-excites the fluorophores in the periphery. Fluorescence can therefore only be detected from the center of the donut, yielding a much higher spatial resolution.

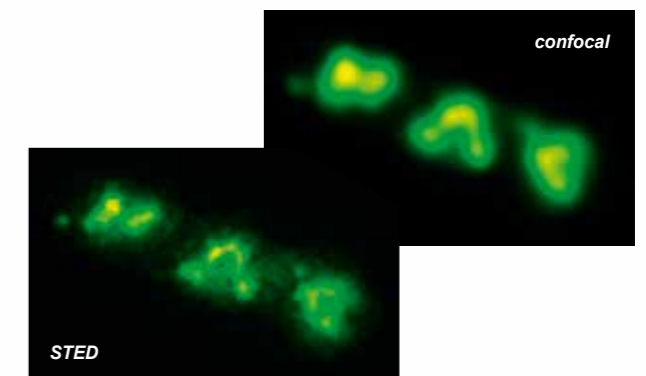

Investigations on the chromosomal organization in E. coli. The bacteria were incubated with EdU and labeled with Atto647N via click-chemistry. Image size: 3.8 μm x 6 μm

Sample courtesy of Mike Heilemann, Goethe University Frankfurt, Germany

STED with the MicroTime 200

Easy donuts (for the MicroTime 200)

STED microscopy uses the principle of stimulated emission based depletion. After exciting fluorophores in the laser focus, a second, donut-shaped focus of a laser with longer wavelength is used to actively de-excite the molecules in the periphery via stimulated emission. In the MicroTime 200, the donut is created using a so-called EASYDONut phase plate. It is inserted into the beam path and changes the STED laser focus to a donut-shape, while leaving the excitation laser unaffected. This simple implementation makes spatial alignment of the two laser beams, which emerge from the same optical fiber, unnecessary.

Resolution below 50 nm

Optical resolution is defined as the smallest distance of two emitters where they can still be distinguished from a single emitter. It is often, and especially in super-resolution microscopy, quantified by the full width at half maximum (FWHM) of the intensity image of single point emitters. The resolution is usually determined by imaging nanometer sized fluorescent beads, from which the FWHM can then be deduced. While the standard MicroTime 200, as well as every other confocal microscope, has an optical resolution of about 250 nm in case of excitation in the red spectral range, STED pushes the optical resolution of the MicroTime 200 below 50 nm.

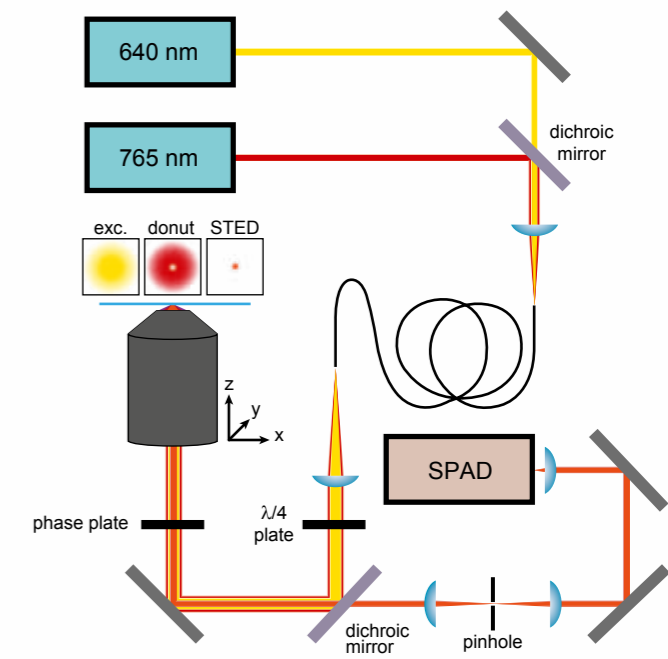

The core components for STED using the MicroTime 200 are the excitation laser at 640 nm and the STED laser at 765 nm, coupled into and out of one polarization maintaining single-mode optical fiber, a quarter wave plate, the dichroic mirror, and the phase plate. For detection, the fluorescence light passes the dichroic mirror and is focussed onto a pinhole and then onto the single photon sensitive detector(s).

Triple-species imaging

STED can not only be performed using a single type of fluorophore. With the MicroTime 200 it is even possible to study samples labeled with three types of fluorophores. Labeling in such a manner is crucial for studying the interaction and co-localization of different proteins. The MicroTime 200 STED can distinguish different fluorophores by using three excitation wavelengths in the red or orange spectral range, and by separating the data using a unique fluorescence pattern matching approach that is integrated into the system software SymPhoTime 64.

Examples

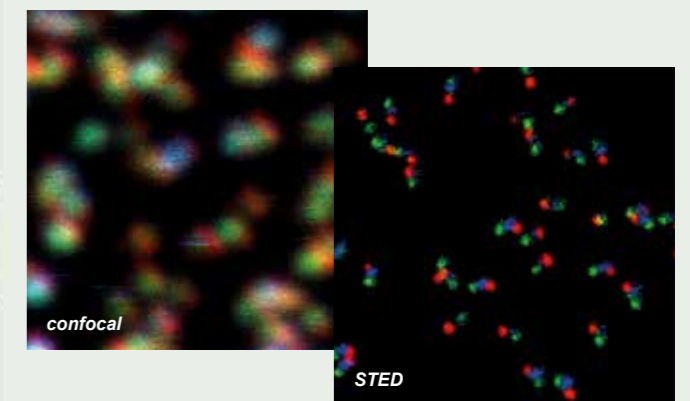
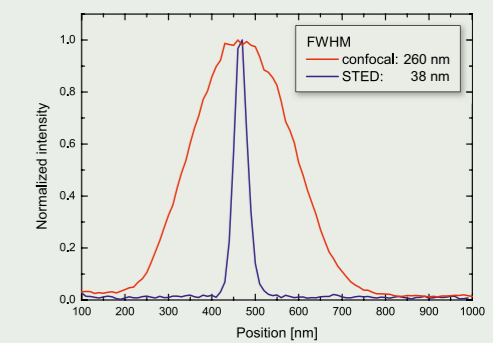

Fluorescent 3-species-origami are often used to determine the resolution of a microscope. The FWHM in the confocal image is 260 nm, whereas in the STED image it is 38 nm. Image size: 1.45 μm x 1.45 μm

Two fluorescent species can be distinguished by Pulsed-Interleaved Excitation (PIE) with two slightly shifted wavelengths and detection of the fluorescence in two spectral bands. Fluorescence pattern matching was used to identify the contributions of each fluorophore. The example shows tubulin labeled with Abberior STAR 635P (green) and giantin labeled with Atto647N (red) utilizing a single STED laser wavelength and excitation at 634 nm and 660 nm.

Sample courtesy of Markus Sauer, University of Würzburg, Germany



The holder for the phase plate was designed for easy exchange and simple alignment.

STED beyond imaging

Higher resolution, more information

STED significantly enhances the resolution of confocal fluorescence microscopy. This allows researchers to distinguish structures that are concealed in conventionally acquired images. STED can, however, not only be used for imaging, but also opens up new possibilities for other fluorescence methods such as Fluorescence Correlation Spectroscopy to maximize the amount of accessible information.

STED improves FCS

STED can not only be used for imaging, where the smaller focus yields higher spatial resolution, but also improves Fluorescence Correlation Spectroscopy (FCS) measurements. By varying the intensity of the STED laser, the diameter of the effective observation volume can be adjusted. A smaller volume allows FCS at higher fluorophore concentrations. Collecting data at different observation volume diameters can help to disentangle complex 2D diffusion scenarios in heterogeneous samples such as biological membranes.

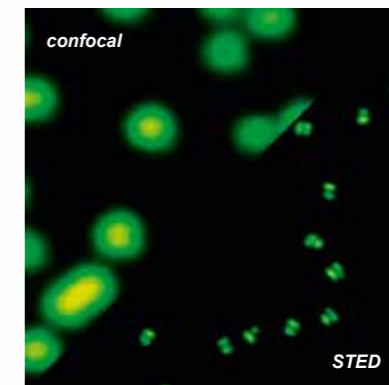

Specifically labeled DNA origami is now commonly used to evaluate the resolution of diffraction-limit-breaking microscopes. Here, origami with two rows of 11 dye molecules with a distance of 71 nm was used. Image size: 3 μm x 3 μm . The samples were provided by GATTAquant GmbH and the Tinnefeld lab, TU Braunschweig, Germany.

“The MicroTime 200 is the ideal platform for STED-FCS microscopy.”

*Christian Eggeling,
University of Oxford, UK*

gSTED for smaller observation volume

The effective observation volume can be further decreased by photon filtering. Photons emitted shortly after excitation have a higher probability to stem from molecules being illuminated by the STED laser. Photons emitted late relative to the excitation pulse are most probably emitted by molecules in the depletion free donut center. Therefore, by selecting late photons with a time-gate, the effective observation volume is reduced. This principle, called gated STED or gSTED*, is exploited in the MicroTime 200 STED to achieve smaller volumes in FCS and an enhanced resolution in images.

*licensed from Max-Planck Society and German Cancer Research Center (DKFZ)

Examples

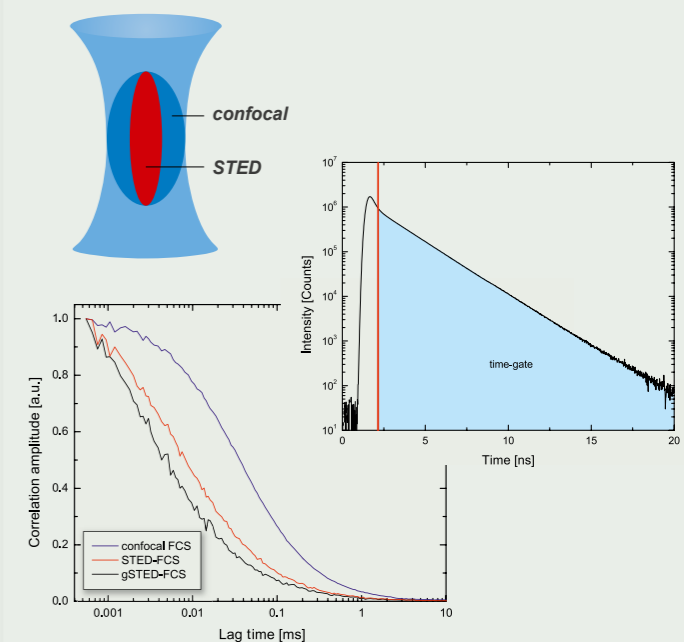

The example shows FCS of Atto655 in water using the standard confocal (blue) and STED (red) configuration. Due to the smaller detection volume in the STED experiment, the FCS curve is shifted to shorter lag times. By applying a time-gate that rejects early photons, the observation volume is decreased even more, leading to a further shift of the FCS curve towards shorter lag times (gSTED, black).

The MicroTime 200 Platform

Examples

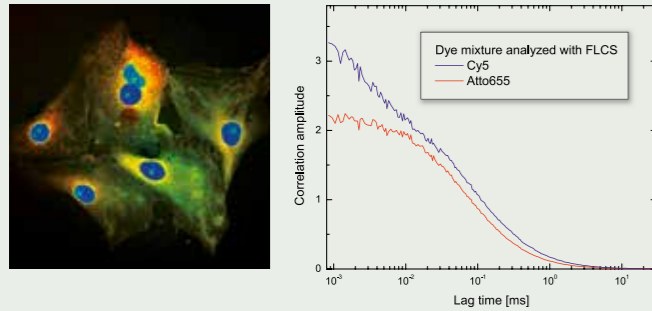

The MicroTime 200 is an ideal tool for Fluorescence Lifetime Imaging (FLIM, left image) and Fluorescence (Lifetime) Correlation Spectroscopy (F(L)CS, right image).

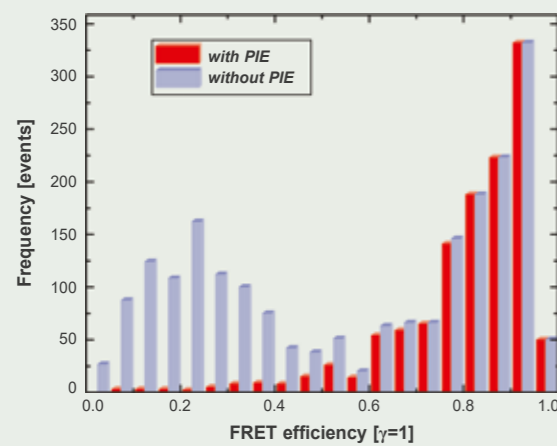

Pulsed-Interleaved Förster Resonance Energy Transfer (PIE-FRET) measurements allow to remove the peak at low FRET efficiencies, which is due to incomplete FRET-pairs.

An open platform design

The MicroTime 200 was developed as an open platform that can be modified to meet the latest trends and requirements in today's research. One key factor for that capability is a special scanning configuration that does not restrict the sample space of the microscope.

An easy access to all optical elements is also granted and permits to adapt the system to special measurement purposes. Many excitation sources and detector types are supported and the configuration of the beam path can be flexibly adjusted by the user. Various imaging methods and spectroscopic measurement modes are already integrated, and the system is continuously adapted in order to realize new ideas and measurements.

The MicroTime 200 STED consists of an Olympus IX 73 or IX 83 microscope body, the main optical unit (MOU, right), the laser combining units (top left), and the system electronics (microscope controller, bottom left). Laser and detection shutters can also be operated using a remote control (in front of the MOU).

The MicroTime 200 in short

- Time-resolved confocal microscope for, e.g., FLIM, FCS, FLIM-FRET, FLCS, 2fFCS, PIE, intensity time traces, ...
- Flexible combinations of pulsed excitation lasers
- FLIMbee galvo scanning
- NEW: scanning FCS available via line scan in x using FLIMbee galvo scanner
- Up to six independent detection channels with single photon sensitivity
- Time-resolved data acquisition with picosecond resolution
- Versatile platform that supports the following add-ons: spectrograph, AFM, cryostat, deep-UV, climate chamber, TIRF, widefield CCD detection, ...
- Intuitive software for data acquisition and analysis (FLIM, FCS, FLIM-FRET, FLCS, 2fFCS, PIE, ...)
- Online tutorials for data analysis and experimental procedures
- Open software platform

Please note that not all methods mentioned above can be combined with STED. Contact us for additional information.

Examples

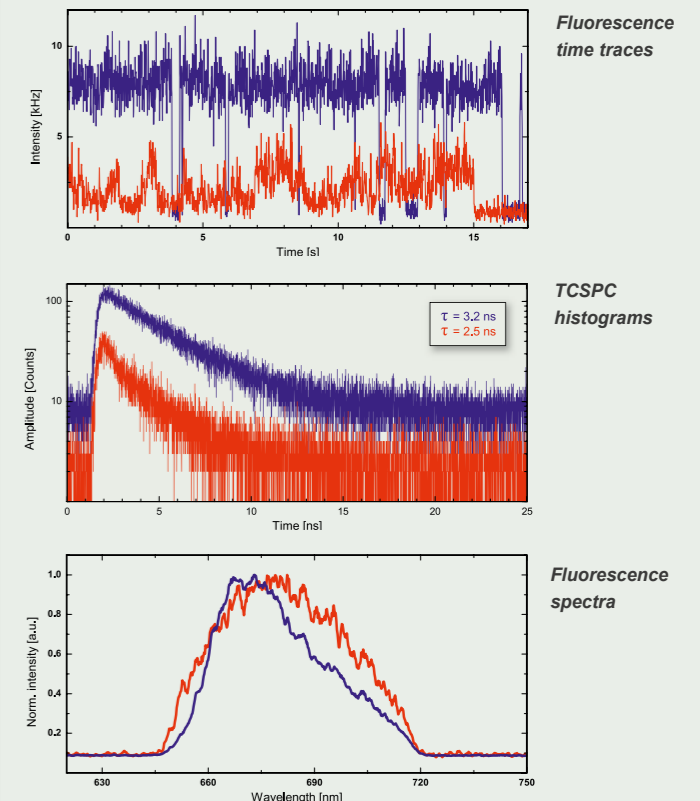

Simultaneous observation of emission spectra and fluorescence parameters from single Atto655 fluorophores immobilized on a glass surface. The blue and the red curve represent the data from two different single molecules.

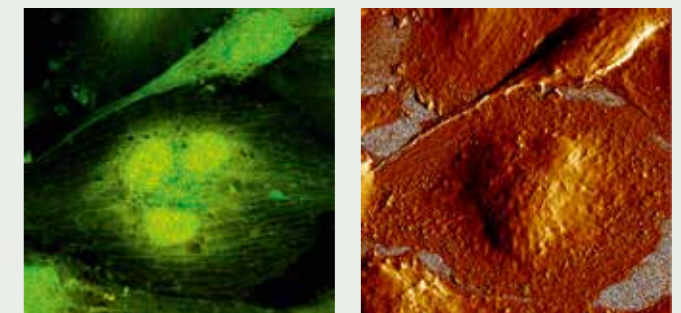

The combination of FLIM (left) and AFM (right) allows to get mechanical as well as chemical information from a sample simultaneously.

In cooperation with Johannes Kindt, Alexandre Barquand, Bruker, Mannheim, Germany



System Software

SymPhoTime 64 – A software package for cutting-edge fluorescence applications

The SymPhoTime 64 software package is an integrated solution for data acquisition and analysis for the MicroTime 200. The clearly structured layout and powerful analysis routines allow the user to focus on the results rather than on data processing.

Time-resolved fluorescence spectroscopy has evolved to become a fundamental method for a widefield of research topics ranging from biological to materials research. These multiple applications put high demands on the capabilities of a software that should address the needs of different users working in time-resolved fluorescence spectroscopy. The conformance to the various requirements were the fundamental design goal of the SymPhoTime 64, a software package that aims at facilitating data acquisition as well as data analysis by providing a clearly structured layout and a wide range of customizable analysis procedures. With the SymPhoTime 64, PicoQuant answers the demands of the ever-evolving area of time-resolved fluorescence spectroscopy.

Features

- Intuitive data acquisition:
 - Single point, multipoint, 3D imaging (xyz)
- Powerful online visualization:
 - FLIM, FCS, time traces or TCSPC histograms
- Image analysis:
 - FLIM, FRET, anisotropy, multiple ROIs, ...
- Correlation analysis:
 - FCCS, antibunching, total correlation, ...
- Super-resolution STED:
 - Simultaneous confocal and STED imaging, gSTED for resolution enhancement, pattern matching for multicolor STED, STED-FCS, STED-FLCS, ...
- Time trace analysis:
 - MCS, (PIE-)FRET, On/Off histograms, anisotropy, ...
- Integrated scripting language:
 - User-defined analysis procedures, GUIs, additional fitting models, ...
- Intuitive user interface:
 - Data workspace, user-defined settings, different themes, ...

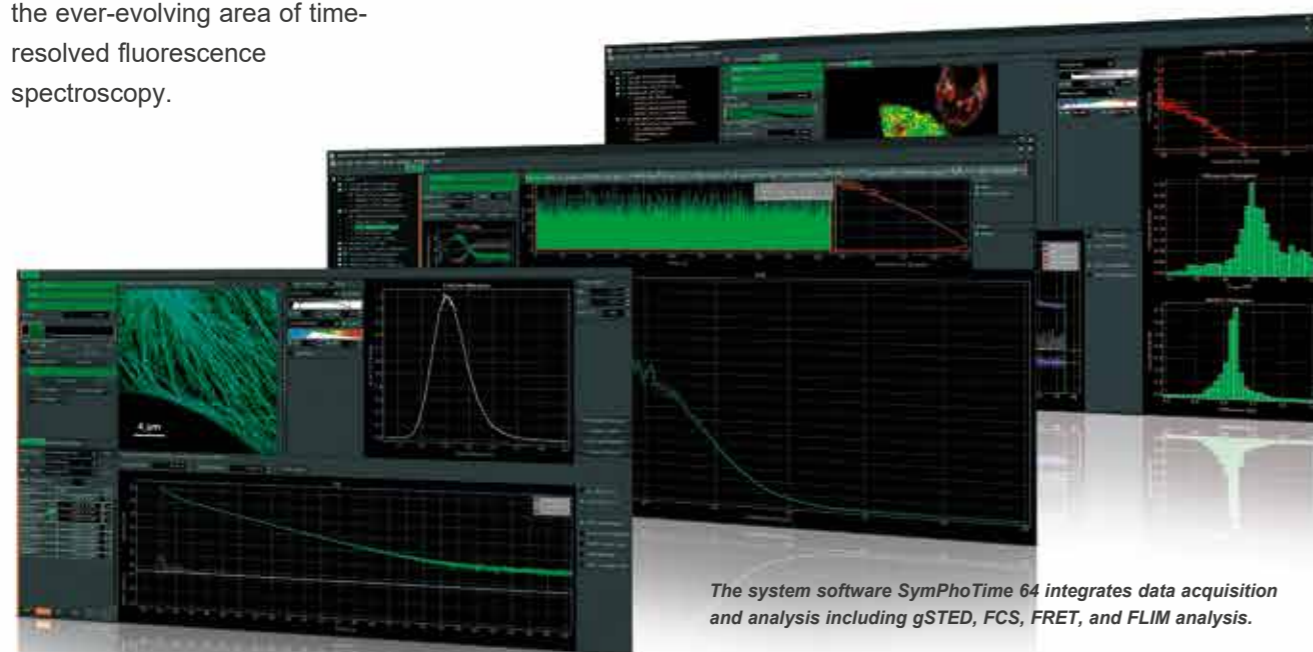

The system software SymPhoTime 64 integrates data acquisition and analysis including gSTED, FCS, FRET, and FLIM analysis.

Specifications

Optical resolution

- Below 50 nm (STED)
- Below 300 nm (confocal)

Excitation system

- Picosecond diode lasers (405-900 nm) with repetition rates up to 80 MHz inside a compact Laser Combining Unit
- Single or multichannel laser driver
- Optional: external laser (e.g., Titanium:Sapphire laser)

For STED

- 640 nm (excitation), 765 nm (STED laser)
- Triple species STED with 595, 640 and 660 nm excitation
- Optional: confocal imaging with 485 and 510 nm



Microscope

- Inverted microscope IX 73 or IX 83 from Olympus
- Specially designed right side port for confocal microscope
- Left side port and back port still accessible (for e.g., widefield imaging or TIRF)
- Transmission illumination unit included
- Special manual sample positioning stage with 25 mm range
- Optional: cryostat for low temperature measurements
- Optional: combination with Atomic Force Microscope (AFM), **not simultaneously with STED**
- Optional: incubator for life cell imaging

Objectives

- Air objectives with 20x and 40x magnification (standard)
- Various high-end objectives available (**100x 1.4 NA oil immersion for STED**, additional oil/water immersion, air spaced, IR/UV-enhanced, TIRF, or long working distance objectives)

Scanning

- Comprehensive software control via SymPhoTime 64
- Fast galvo scanner (FLIMbee) with highly flexible scanning speeds (mandatory for rapidFLIM, **highly recommended for STED**), see our FLIMbee brochure for details
- Available in combination with z stage for 3D imaging

Main optical unit

- Confocal detection set-up in a well-arranged housing with up to six parallel detection channels
- Specialized high-end major dichroics with enhanced stability
- All optical elements easily accessible, adjustable, and exchangeable
- CCD camera for beam diagnostics and photodiode for relative power measurements
- Variable beam-splitting units and exit ports to connect external devices

Detectors

- Single photon avalanche diodes (**highly recommended for STED**)
- Hybrid photomultiplier tubes

Data acquisition

- Based on the method of Time-Correlated Single Photon Counting (TCSPC) in the unique Time-Tagged Time-Resolved (TTTR) mode
- Simultaneous data acquisition of up to six detection channels

Please note that not all methods mentioned above can be combined with STED. Contact us for additional information.

LASER 2000

For UK & Ireland enquiries:

☎ +44 (0) 1933 461 666

✉ sales@laser2000.co.uk

🖱 photonics.laser2000.co.uk

Sample courtesy of Christian Eggeling, University of Oxford, UK

PicoQuant GmbH
Rudower Chaussee 29 (IGZ)
12489 Berlin
Germany
Phone: +49-(0)30-1208820-0
info@picoquant.com
www.picoquant.com

Published by: PicoQuant GmbH
October 2019
Editorial and production: Pink Lemon Werbeagentur
Tina Stundner, Berlin
Photos: PicoQuant GmbH
Corporate names, trademarks stated herein are the property
of their respective companies.

