

XY Axis Stainless Steel Extended Contact Translation Stages

Stage Size 25 × 25 mm / 40 × 40 mm / 60 × 60 mm / 65 × 65 mm

TSDS-2

RoHS

Stainless Steel Linear Stages suitable for hard vacuum and clean room applications. Made entirely of stainless steel, they yield excellent corrosion resistance. The stage bearingways and the stainless steel micrometer heads are lubricated with a high grade vacuum grease (YVAC2).

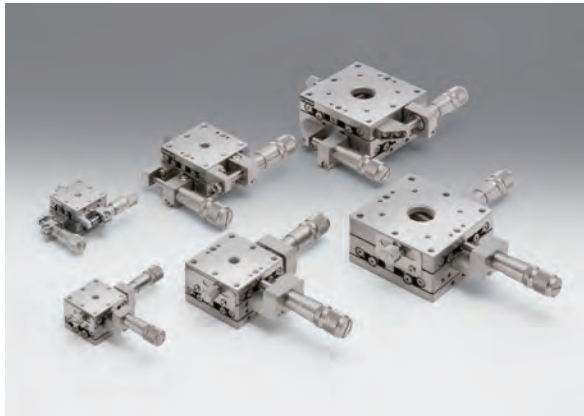

Guide

► The TSDS series stages are suitable for use in clean rooms or vacuum applications.

Reference Vacuum measurement data E205

Also ideal for use in airtight spaces that have to avoid outgassing.

Attention

► Micrometer brackets may extend above the top surface of some stages. Check drawings for detailed information.

► Note that based upon payload size, rated travel could be reduced.

Specifications									
Part Number	METRIC	TSDS-252C	TSDS-252S	TSDS-402C	TSDS-402S	TSDS-602C	TSDS-602S	TSDS-652C-M6	TSDS-652S-M6
	INCH	—	—	TSDS-402CUU	TSDS-402SUU	—	—	TSDS-652CUU	TSDS-652SUU
Stage Size [mm]		25×25	25×25	40×40	40×40	60×60	60×60	65×65	65×65
Axes of Travel		XY axis							
Micrometer Position		Center	Side	Center	Side	Center	Side	Center	Side
Travel [mm]		±3	±3	±6.5	±6.5	±6.5	±6.5	±6.5	±6.5
Lead of Actuator [mm/rotation]		0.5	0.5	0.5	0.5	0.5	0.5	0.5	0.5
Micrometer Readable Resolution [mm]		0.01	0.01	0.01	0.01	0.01	0.01	0.01	0.01
Guide Method		Extended contact ball bearing guide							
Primary Material		Stainless steel							
Finish		None							
Load Capacity [N]		49 (5.0kgf)	49 (5.0kgf)	147 (15.0kgf)	147 (15.0kgf)	343 (35.0kgf)	343 (35.0kgf)	343 (35.0kgf)	343 (35.0kgf)
Travel Accuracy	Straightness [μm]	0.5	0.5	0.5	0.5	0.5	0.5	0.5	0.5
	Pitch [′]	30	30	30	30	25	25	25	25
	Yaw [′]	25	25	25	25	15	15	15	15
Max. Moment Capacity	Pitch [N·m]	3.0	3.0	3.9	3.9	6.4	6.4	8.8	8.8
	Roll [N·m]	3.0	3.0	3.9	3.9	6.4	6.4	8.8	8.8
	Yaw [N·m]	1.5	1.5	2.5	2.5	4.9	4.9	4.9	4.9
Moment Stiffness	Pitch [′/N·cm]	3.4	3.4	0.66	0.66	0.41	0.41	0.41	0.41
	Roll [′/N·cm]	3.4	3.4	0.66	0.66	0.41	0.41	0.41	0.41
	Yaw [′/N·cm]	4.0	4.0	0.8	0.8	0.41	0.41	0.41	0.41
Parallelism [μm]		50	50	30	30	30	30	50	50
Running Parallelism [μm]		20	20	20	20	20	20	20	20
Orthogonality [μm]		10	10	10	10	10	10	10	10
Weight [kg]		0.1	0.1	0.3	0.3	0.9	0.9	1.2	1.2

Application Systems

Optics & Optical Coatings

Opto-Mechanics

Bases

Manual Stages

Actuators & Adjusters

Motorized Stages

Light Sources & Laser Safety

Index

Guide

X Axis Stages

XY Axis Stages

Z Axis Stages

XZ Axis Stages

XYZ Axis Stages

Rotation Stages

Goniometer

Tilt Stages

Vacuum

Ball Bearing Guide

Crossed Roller

Dovetail

Lapping

V Groove Screw

Others

15 × 15 mm

25 × 25 mm

40 × 40 mm

60 × 60 mm

65 × 65 mm

80 × 80 mm

100 × 100 mm

120 × 120 mm

Others



Outline Drawing

TSDS-252C Hexagon socket head cap screw (stainless steel construction) M2×4...4 screws

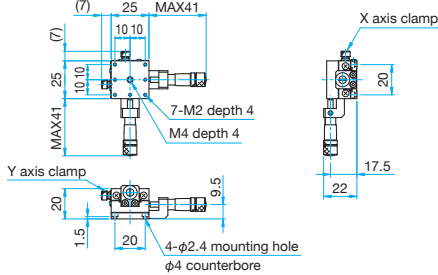

TSDS-252S Hexagon socket head cap screw (stainless steel construction) M2×4...4 screws

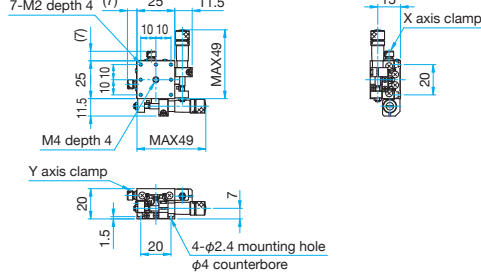

TSDS-402C/402CUU

Hexagon socket head cap screw (stainless steel construction) M3×6...4 screws, Spring washers
Hexagon socket head cap screw (stainless steel construction) 6-32UNC×3/16...4 screws (UU)

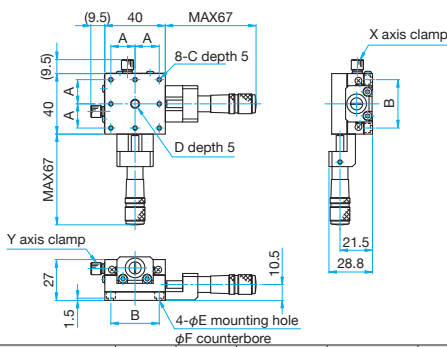

TSDS-402S/402SUU

Hexagon socket head cap screw (stainless steel construction) M3×6...4 screws, Spring washers
Hexagon socket head cap screw (stainless steel construction) 6-32UNC×3/16...4 screws (UU)

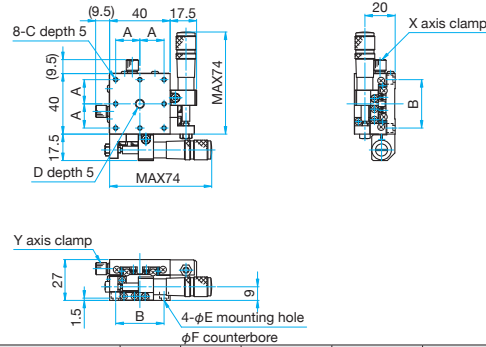

Part Number	A (mm)	B (mm)	C	D	E (mm)	F (mm)
TSDS-402C	16	32	M3	M6 P1	3.5	6
TSDS-402CUU	15.875	31.75	6-32UNC	1/4-20UNC	4	6.5

Part Number	A (mm)	B (mm)	C	D	E (mm)	F (mm)
TSDS-402S	16	32	M3	M6 P1	3.5	6
TSDS-402SUU	15.875	31.75	6-32UNC	1/4-20UNC	4	6.5

TSDS-602C Hexagon socket head cap screw (stainless steel construction) M4×6...4 screws

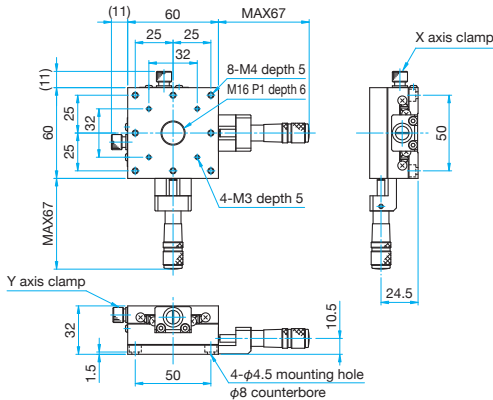

TSDS-602S Hexagon socket head cap screw (stainless steel construction) M4×6...4 screws

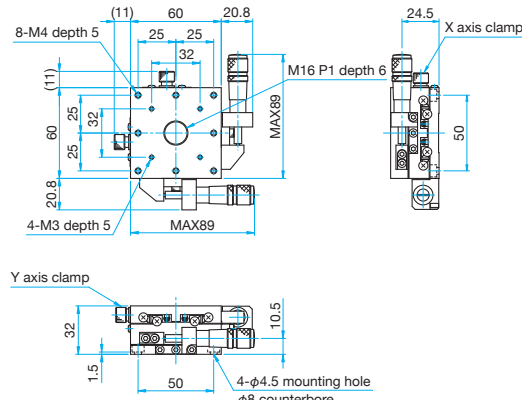

TSDS-652C-M6/652CUU

Hexagon socket head cap screw (stainless steel construction) M6×6...4 screws (M6)
Hexagon socket head cap screw (stainless steel construction) 1/4-20UNC×1/4...4 screws (UU)

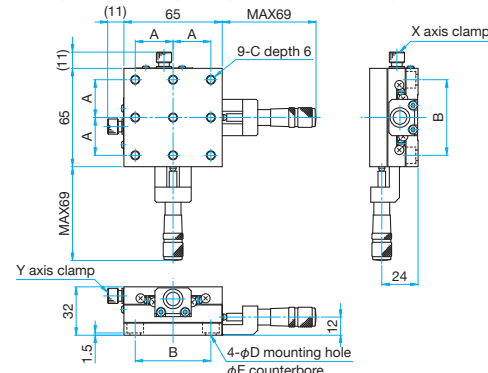

TSDS-652S-M6/652SUU

Hexagon socket head cap screw (stainless steel construction) M6×6...4 screws (M6)
Hexagon socket head cap screw (stainless steel construction) 1/4-20UNC×1/4...4 screws (UU)

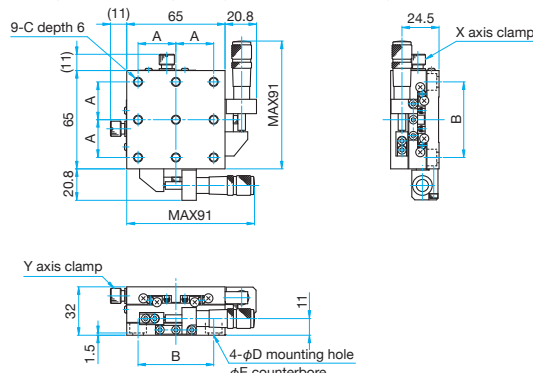

Part Number	A (mm)	B (mm)	C	D (mm)	E (mm)
TSDS-652C-M6	25	50	M6 P1	6.5	11
TSDS-652CUU	25.4	50.8	1/4-20UNC	7	12

Part Number	A (mm)	B (mm)	C	D (mm)	E (mm)
TSDS-652S-M6	25	50	M6 P1	6.5	11
TSDS-652SUU	25.4	50.8	1/4-20UNC	7	12

Application Systems

Optics & Optical Coatings

Opto-Mechanics

Bases

Manual Stages

Actuators & Adjusters

MotORIZED Stages

Light Sources & Laser Safety

Index

Guide

X Axis Stages

XY Axis Stages

Z Axis Stages

XZ Axis Stages

XYZ Axis Stages

Rotation Stages

Goniometer

Tilt Stages

Vacuum

Ball Bearing Guide

Crossed Roller

Dovetail

Lapping

V Groove Screw

Ohters

15 × 15 mm

25 × 25 mm

40 × 40 mm

60 × 60 mm

65 × 65 mm

80 × 80 mm

100 × 100 mm

120 × 120 mm

Others