

TELECENTRIC LASER PROJECTOR

Telecentric micron thin line projector for high precision 3D structured lighting inspection applications.

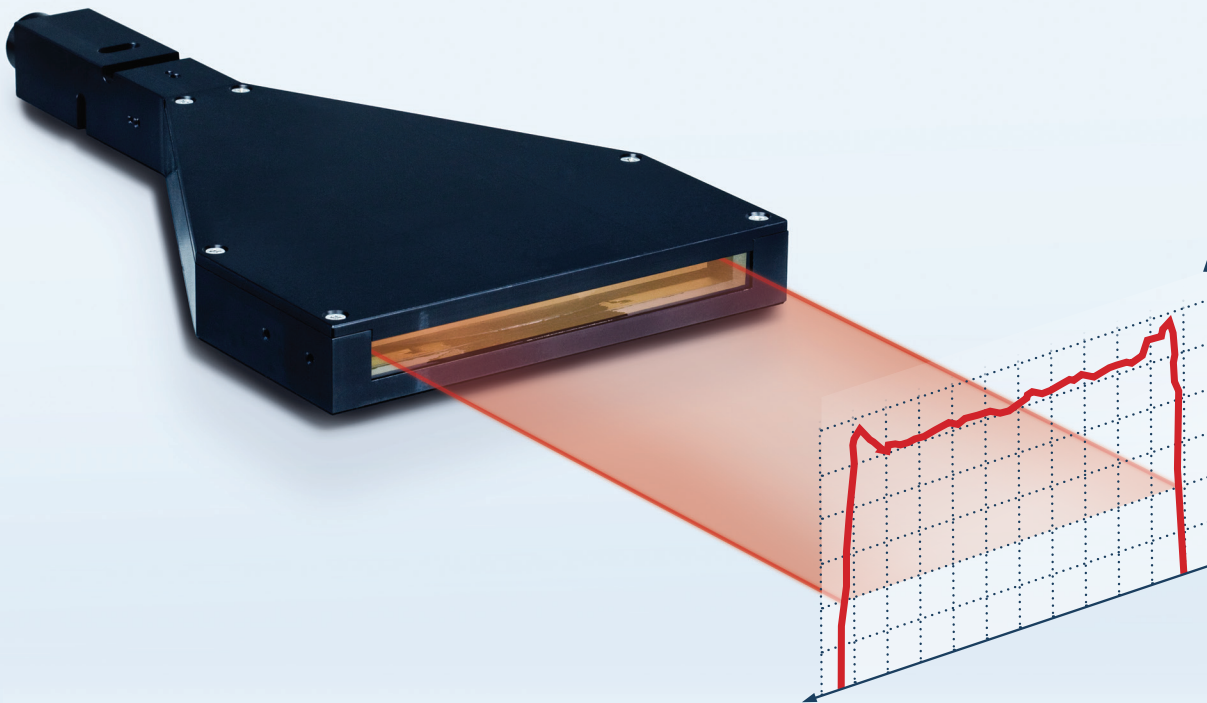

FEATURES

- Constant thickness over entire line length
- Collimated line length
- Reduced image occlusion
- Line thickness down to $5\mu\text{m}$
- Line length up to 100mm
- Uniform line intensity profile

Telecentric Laser Projector (TLP) provides parallel non angular laser line illumination as opposed to conventional lasers lines that projects a diverging fan. The TLP has the advantage of reducing object occlusions on your image plane critical for 3D high precision structured lighting applications. In these applications the TLP evenly illuminates the complete part under inspection in order to achieve the measurement accuracy required.

STANDARD LASER

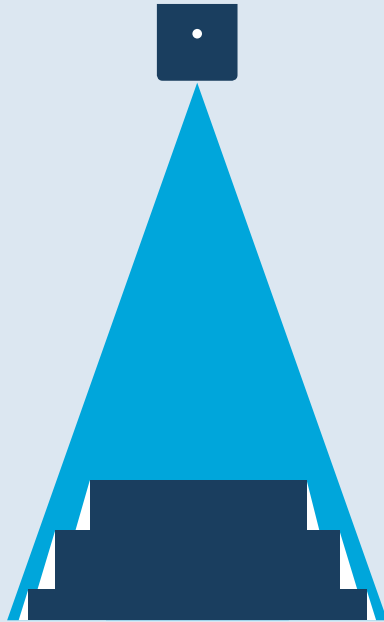

Object occluded

TELECENTRIC LASER

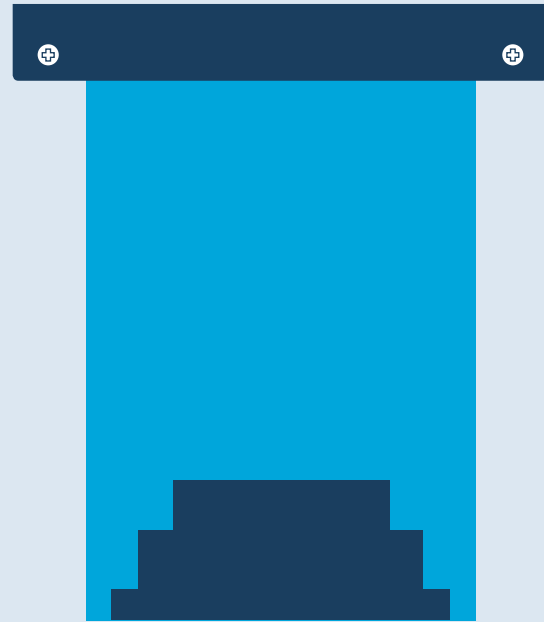

No occlusion

INTENSITY DISTRIBUTION ON A FLAT SCREEN AT FOCAL POSITION

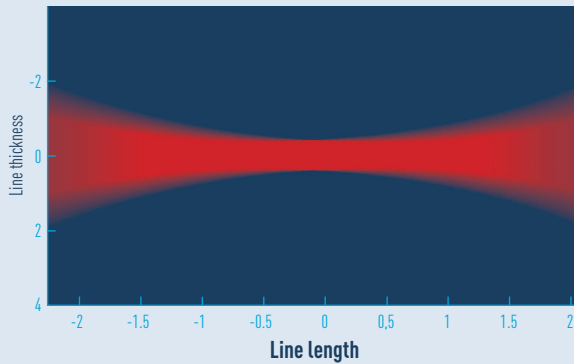

Varying line thickness

INTENSITY DISTRIBUTION ON A FLAT SCREEN AT FOCAL POSITION

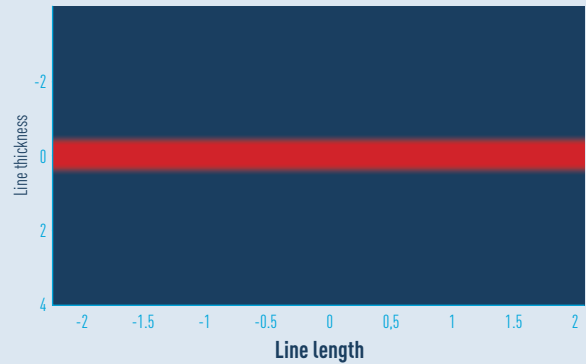

Constant line thickness

Another advantage of the TLP is that its thickness is constant over its entire length. In applications such as semiconductor inspection, it is very important to have micron thin line over the entire length. With conventional fan out laser lines it is not possible to have both a thin line over a wide field due to depth of focus limitations. With the TLP, its parallel non angular illumination design allows for constant micron thin lines over large field of views.

MODULATION

The Telecentric Laser Projector can be modulated by an external 0 to 5V external signal through the white wire. The **S type** modulation is included by default with the Telecentric Module.

FUNCTION	CODE	ON	OFF
TTL	T	0 to 2V	3 to 5V
Reverse TTL	RT	3 to 5V	0 to 2V

Note: One modulation input needs to be selected, S (default), RS, T or RT

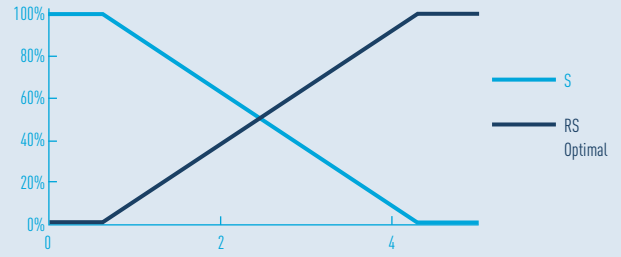

SPECIFICATIONS

Bore sight (mrad)	< 3 mrad
Wavelength Drift	≈ 0.25 nm/ degC
Pointing Stability	< 6 μrad/°C
Modulation Rise/Fall time	< 5μ sec, 100% modulation depth (10 Kohm input impedance)
Protections (Built in)	ESD, Over voltage (up to 30 VDC), Over-temp Shutoff (> 50 deg C)
Long term Power stability (8 hours)	< 3 %, 2 minute warm up time
Operating Voltage	5 ± 0.5VDC, 4.5 to 30V Optional (9-30V for < 635 nm)
Working Temp Range	-10 to to +50 °C (housing)
Weight	< 1500 g
Power Supply Cable	18 inches 3 conductors Belden 9533, with flying leads
ESD Protection	Level 4
Shock Tolerance	30g, 6ms, functional

MECHANICAL SPECIFICATIONS

Example of 10, 55 and 100mm TLP Shown

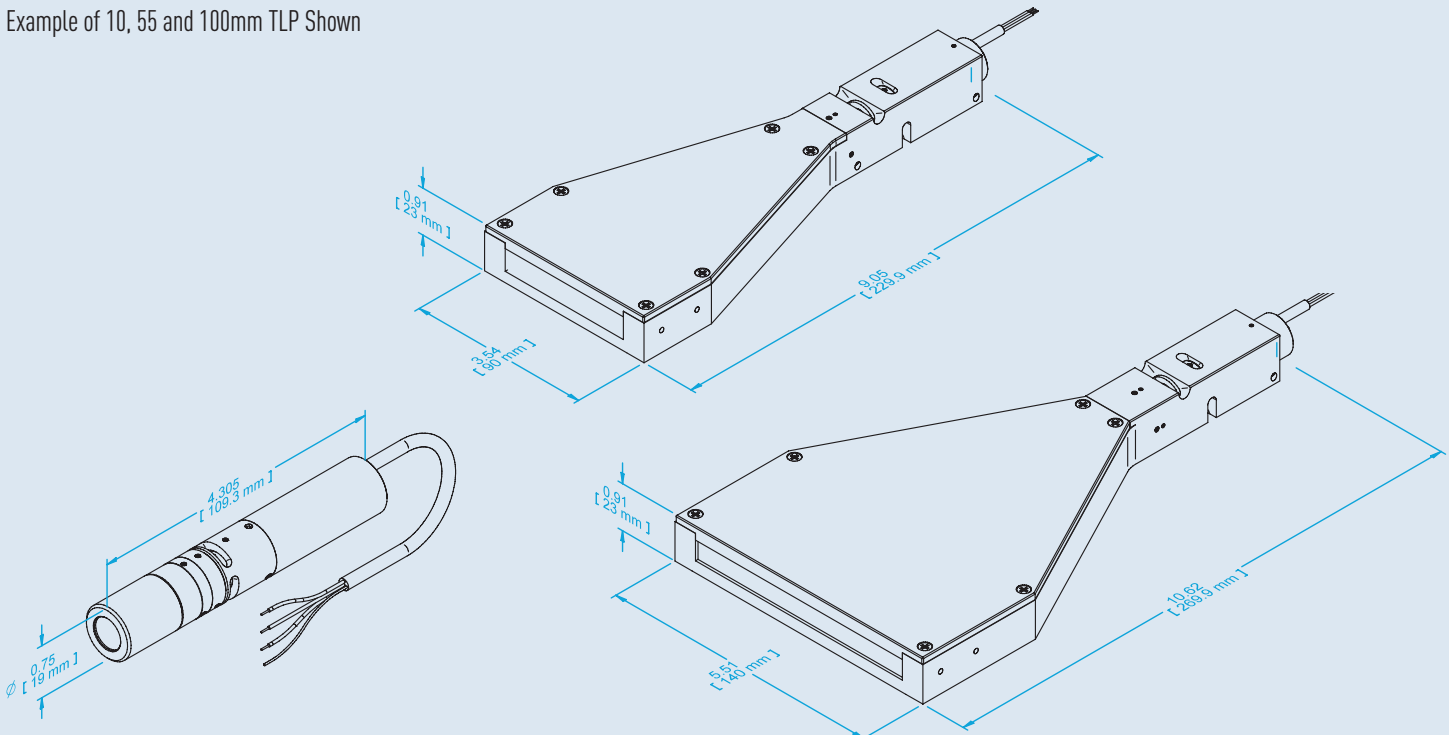

TELECENTRIC SINGLE LINE GENERATOR

FIG 1 - INTENSITY DISTRIBUTION ALONG THE LINE

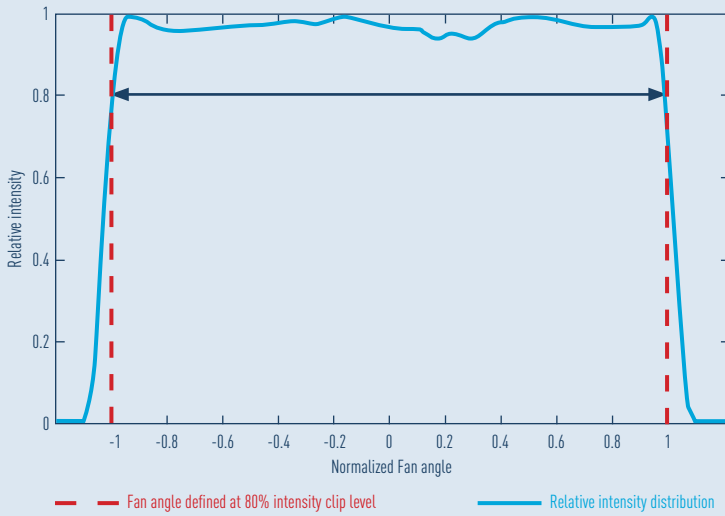
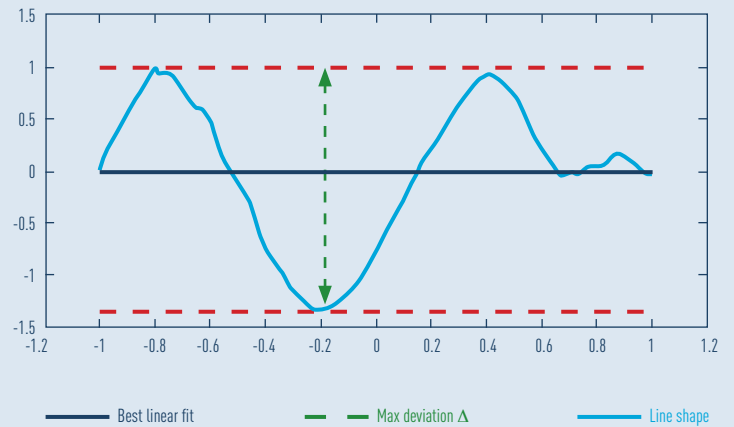

FIG 2 - LINE STRAIGHTNESS



SPECIFICATIONS

SPECIFICATIONS		VALUES
Uniformity (line intensity distribution along the line)	$\frac{I_{max} - I_{min}}{I_{max} + I_{min}}$	20% (typical)
Relative intensity clip that define the fan angle		80%
Contained energy In the fan angle	$\frac{\text{Energy in fan angle}}{\text{total energy}}$	$\geq 95\%$
Line Straightness (deviation from the best linear fit)	$\frac{\Delta}{L \text{ (line length)}}$	$\leq 0.1\%$ $\leq 0.05\%$

ORDERING CODE

Please contact us for laser configuration assistance

TLP	XXX	XXX	X	X	XX	XXX-XX	XXXXX
	Wavelength	Diode Power	Electronic	Line Length	Line Tickness	Working Distance	Option
	405, 450	1	S	Up to	Down to	To specify	SD
	520, 635	to	RS	100mm	5 μ m		24V
	660, 830nm	260mw	T				
			RT				